

# G330 Covering shelf bracket



- Possible to install easily
- Applicable shelf thickness: 20mm (18mm when using spacer)
- Recommended shelf plate size/maximum depth: 200mm, maximum width: 800mm
- Material/ Steel
- Attached screw/TAP flat head 5 × 16 black · white (baked paint)

## Specification dimension

Product number	Finishing	Applicable plate thickness	Load capacity	Quantity
G330-BL	Black (baked paint)	18mm or 20mm	※40kgf	200sets (2 pcs·1 set)
G330-WH	White (baked paint)			

※ Load capacity of depth 200mm, width 800mm

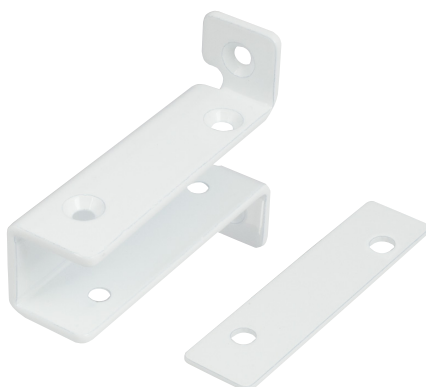

Spacer for 18mm shelf plate thickness (attached)

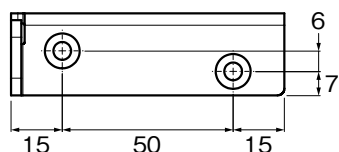
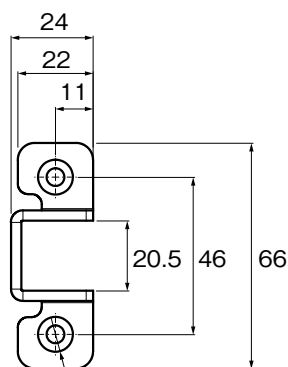
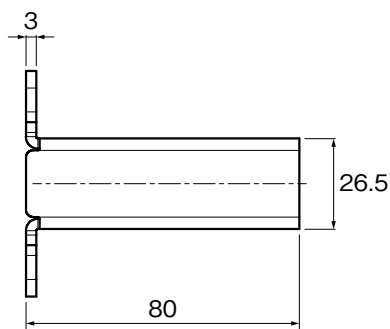
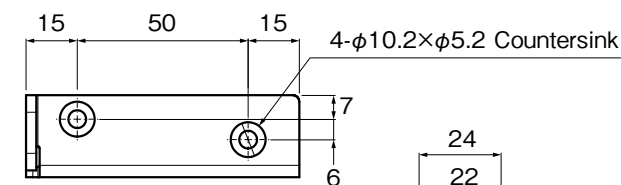
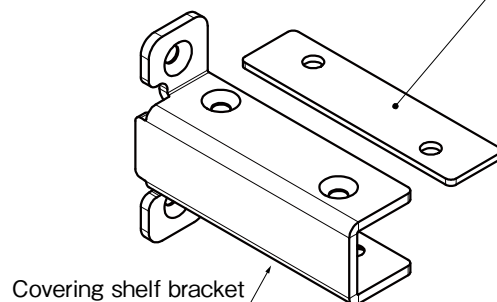

## Spacer for 18mm shelf plate thickness

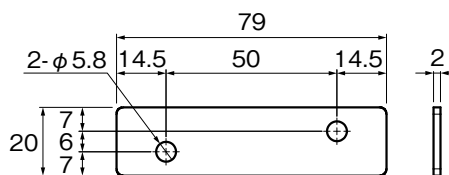

**KOJIMA** METAL FITTING CORPORATION

Head office

3-4-1 Motoasakusa, Taito-ku, Tokyo 111-0041, Japan

TEL +81-3-3843-3141 FAX +81-3-3843-3144

Kasukabe branch

1-26-20 Kasukabehigashi, Kasukabe-shi, Saitama 344-0062, Japan

TEL +81-48-760-3881 FAX +81-48-760-3883

✉ kanamono@kojima-mf.co.jp

