

# G331 Free Pitch Concealed Shelf Support



- Concealed shelf support not to show shelf support.
- Load is dispersed to whole shelf rail, not to each shelf support.
- Easy to install. First of all install support rail to the wall with screws. Next, install it to shelf support rail and move horizontally.
- Installing support rails horizontally makes it to be able to multiple shelf support rails horizontally. It saves energy to level each one separately.
- Easy to cut support rails adjusting to width of shelves because it is made of aluminum. Also can put additional processing of screw holes adjusting to installation position.
- Load capacity/in case of using 2 of G331-HB : 12kgf  
(Tip load in case of less than 700mm pitch, 200mm shelf depth)  
In case of using G331-SR 800mm + 2 of G331-HB: 10kgf  
(Between shelf supports in case of less than 700mm pitch, 200mm shelf support depth)
- Width of shelf board/more than 24mm

## G331-HB Shelf support



- Concealed shelf support not to show shelf support
- Can manage inclination by tightening insertion holes for tilt adjustment
- Material/Steel
- Finishing/Trivalent chromate
- Quantity/100 pcs.

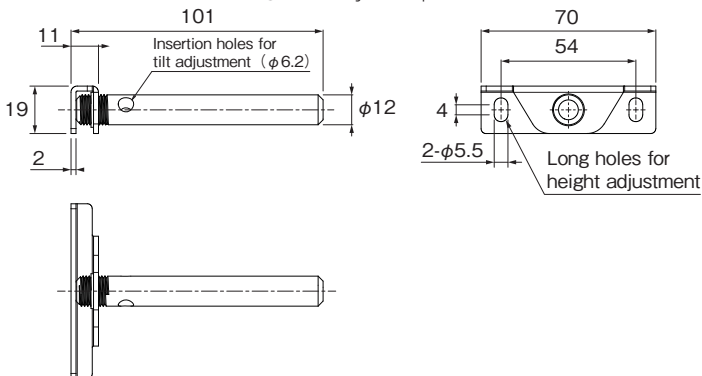

### Optioning products G331-SP Set plate

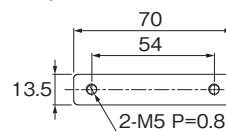

- Necessary items to install shelf support to support rail
- Necessary 1 set plate for 1 shelf support
- Material/Steel
- Finishing/Trivalent chromate
- Accessories/M5 × 8 pan 2 small screws, 2 flat washers
- Quantity/100 pcs.

## G331-SR Support rail

### G331-SR800 Support rail L800 (with hole)

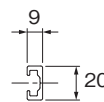
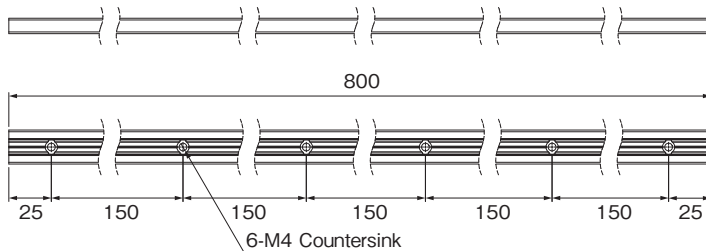

- Material/Aluminum
- Finishing/Anodized aluminum
- Quantity/100 pcs.

\* Installation holes are not processed for G331-SR2000

Please get countersinking in case of using M4 flat head screw



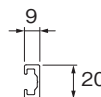
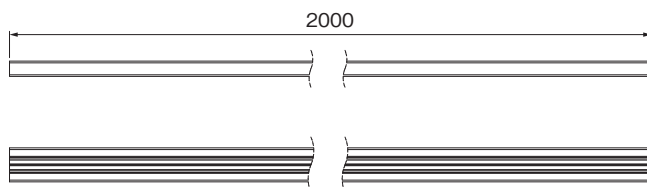

Hole drilling is enough in case of using M4 flat head screw

Make sure that sliding parts inside the rail don't interfere screw heads and screw heads

### G331-SR2000 Support rail L2000 (without holes)

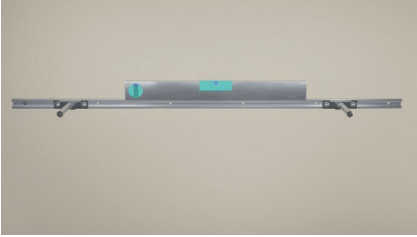
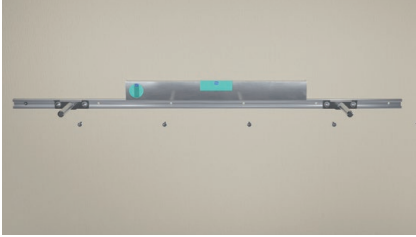

## Installation procedure

- ①  Get ready necessary items
- ②  Put G331-SR set plate in G331-SR support rail
- ③  Install G331-HB shelf support with the accessory screws of G331-SP set plate
- ④  Screwed fasten G331-SR support rail at one place and level it with a leveler
- ⑤  Screwed fasten all screw holes after determining horizontal positions
- ⑥  Install shelf plate and complete

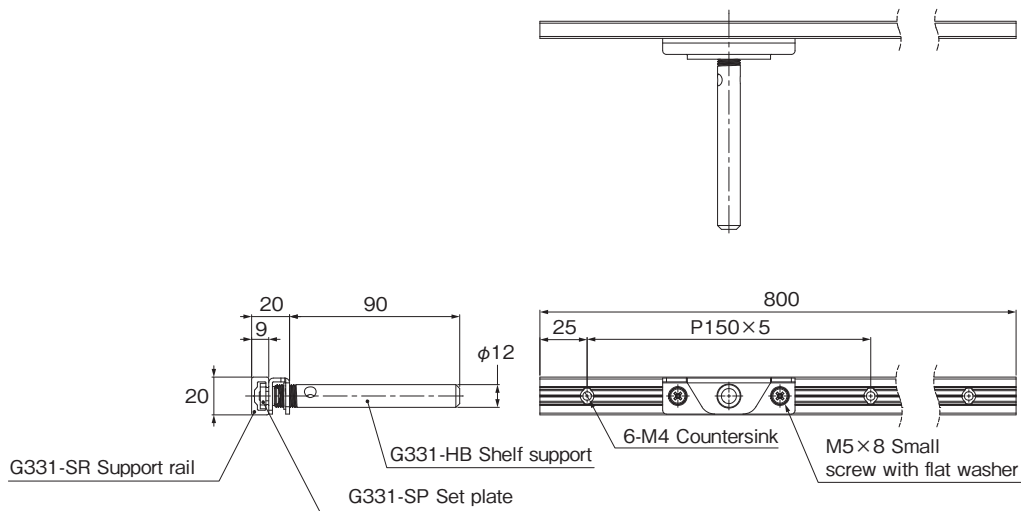

Reference diagram for shelf digging dimensions

