

近日発売予定

# 新しいテーブルシステムの提案

## 3本脚はメリットが多数!!

3本脚のテーブルはガタツキが起きない。

水平でない床での4本脚の場合

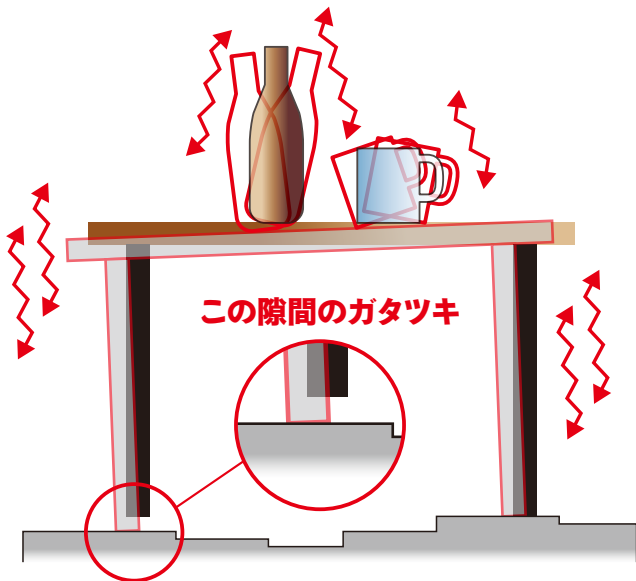

3本脚の場合



ガタツキが起きないので調整の為のアジャスターは必要ありません。  
調整が必要ないのでキャスター脚が使用できます。  
天板の折りたたみ機能も加わり【移動】収納がスムーズにおこなえます。

キャスターの仕様で移動が楽楽!!

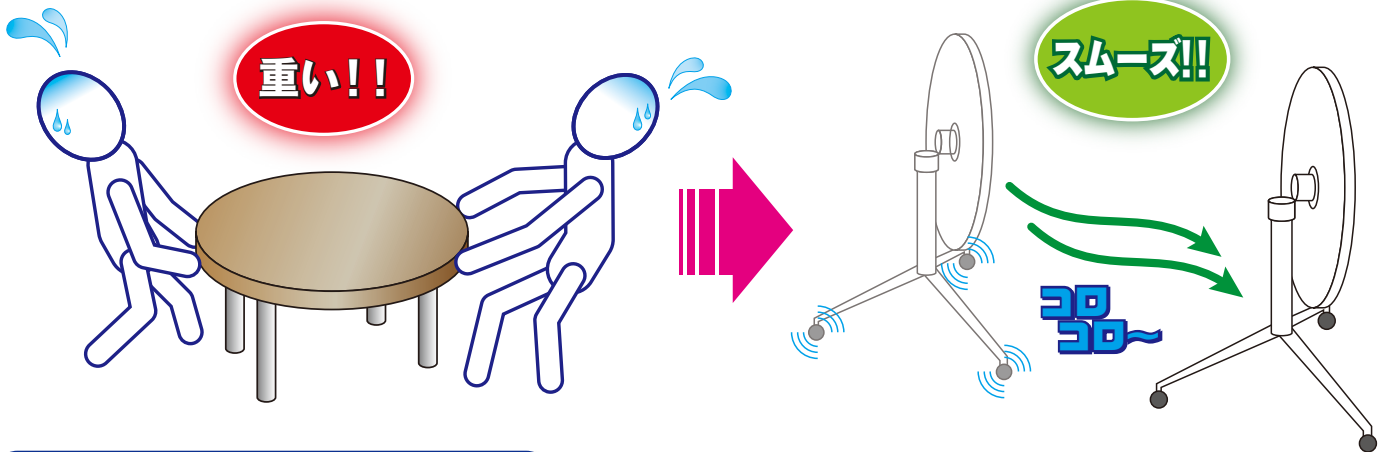

テーブルのセッティングも簡単

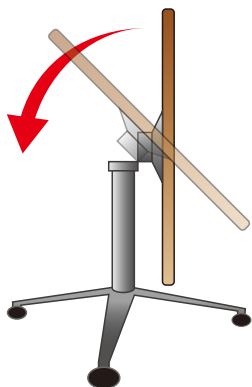

ロックの確認も「カチッ!」と音がするのであんしんです。



収納イメージ

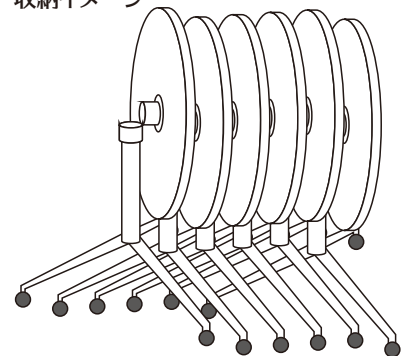



'l'OS' p"  
>"l'e'pw  
Ml Xo` a

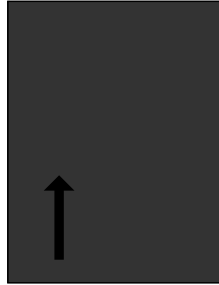

me

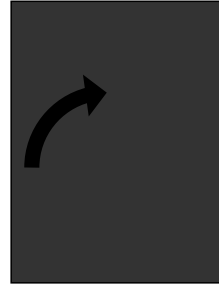

W



.JK

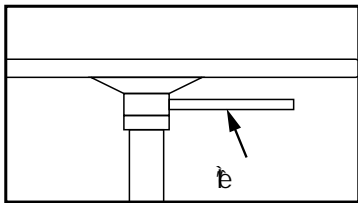
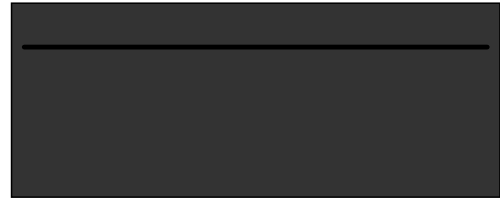
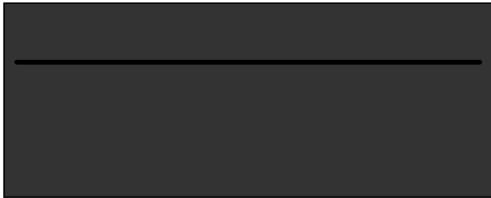

0e

